

CAI2*-H1; CAI2*-P1; CAI2*-P2; 10; 11; 12 Gates – A-F

2; 6; 7; 8; 9 Gates A-E

CAICh2*-P1; 1; 5 Gates – A-D

Ypäjän Osuuspankki



1

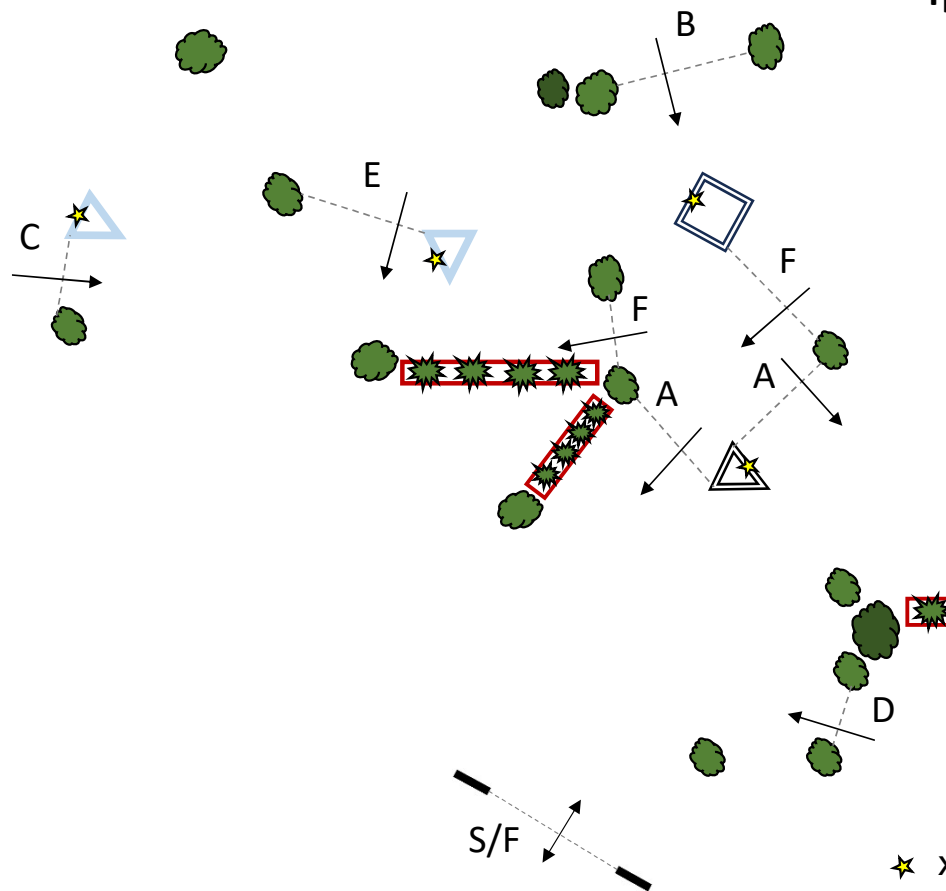

CAI2*-H1; CAI2*-P1; CAI2*-P2; 10; 11; 12 Gates – A-F

2; 6; 7; 8; 9 Gates A-E

CAICh2*-P1; 1; 5 Gates – A-D

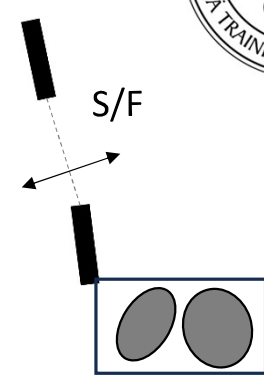
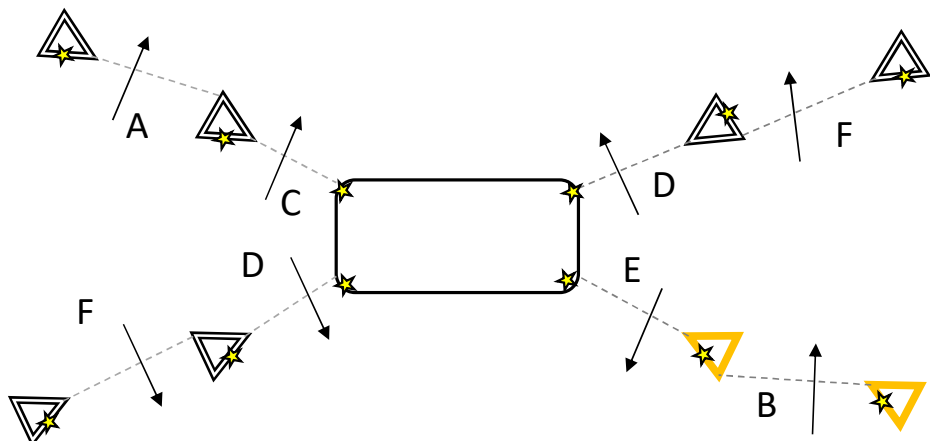
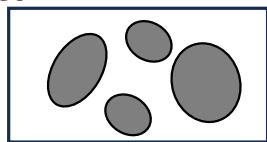

Equine College



2

★ x 12 - dislodgeable elements

CD KRISTAPS CAUNE

CAI2*-H1; CAI2*-P1; CAI2*-P2; 10; 11; 12 Gates – A-F
7; 9 Gates A-E

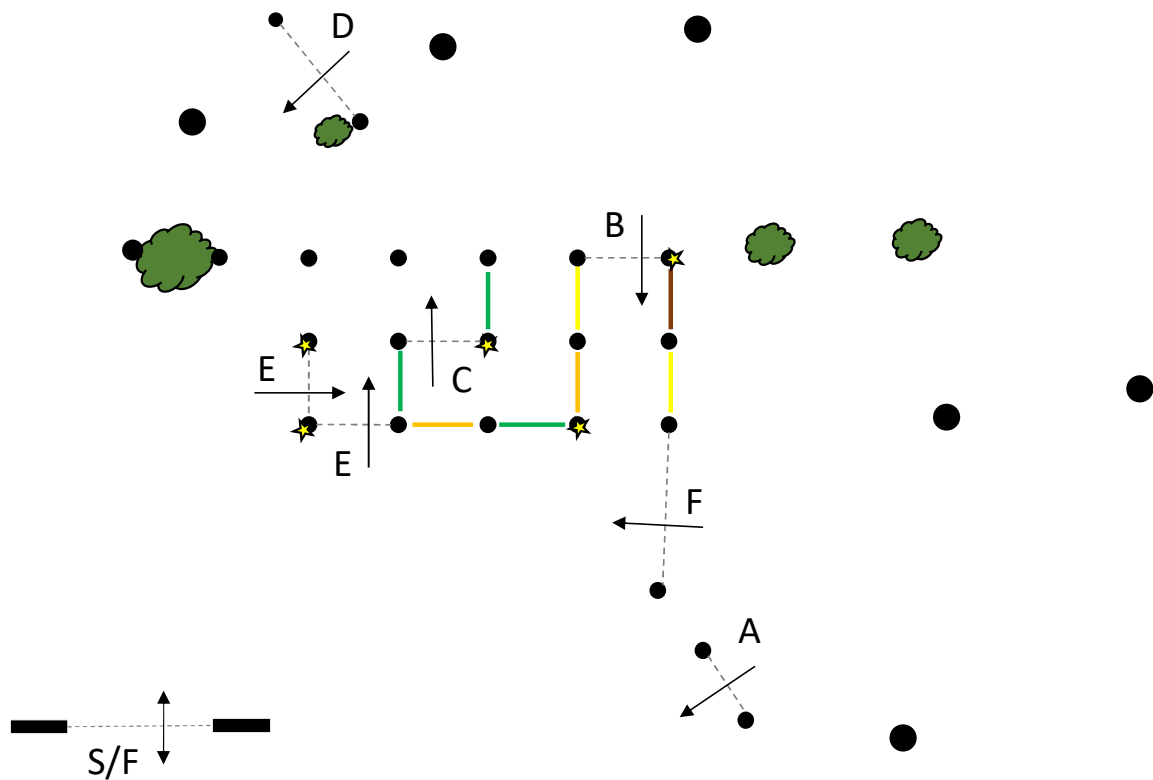

★ x 5 - dislodgable elements

CD KRISTAPS CAUNE

CAI2*-H1; CAI2*-P1; CAI2*-P2; 10; 11; 12 Gates – A-F

2; 6; 7; 8; 9 Gates A-E

CAICh2*-P1 Gates A-D



VaTu ry

4

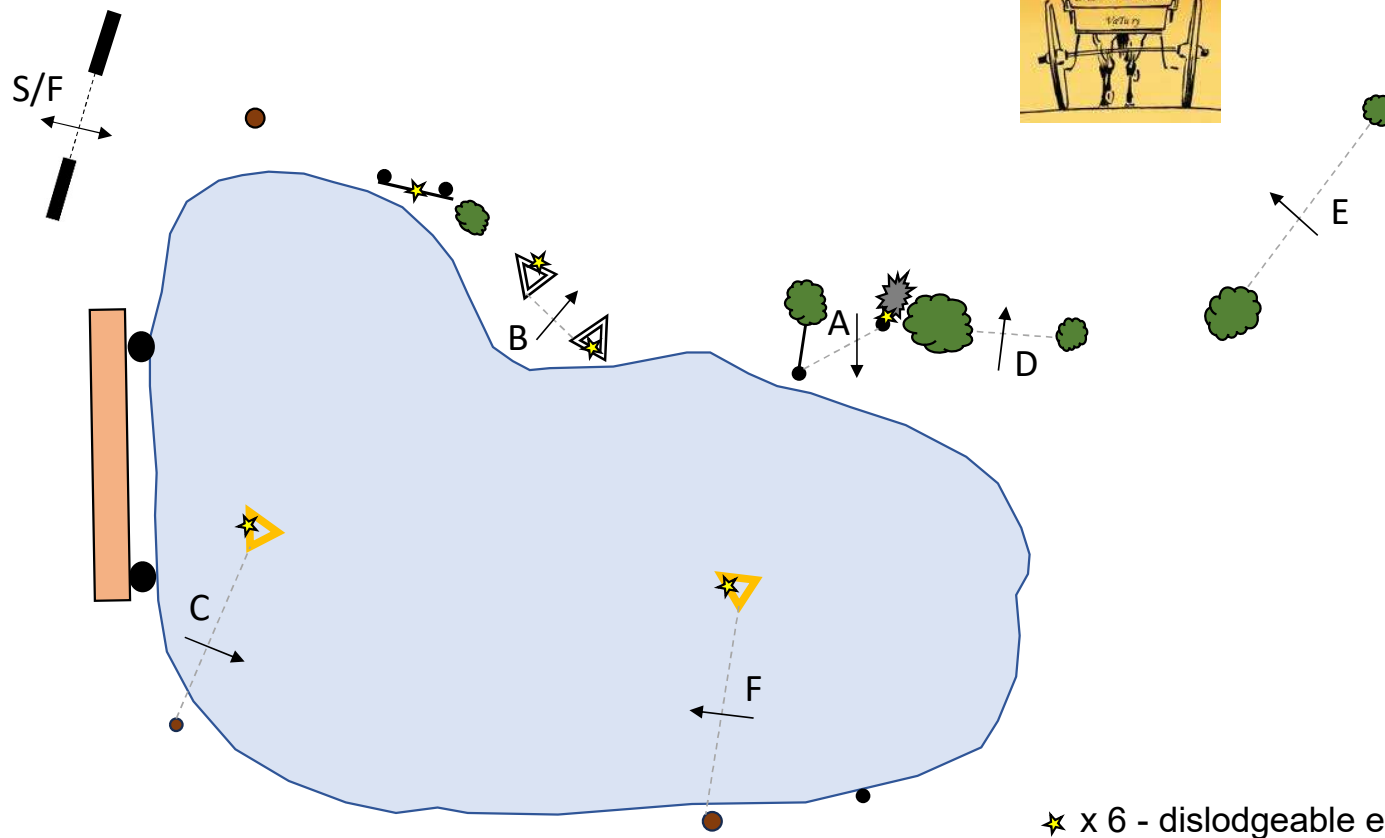

★ x 6 - dislodgeable elements

CD KRISTAPS CAUNE

CAI2*-H1; CAI2*-P1; CAI2*-P2; 10; 11; 12 Gates – A-F
2; 6; 7; 8; 9 Gates A-E
CAICh2*-P1; 1; 5 Gates – A-D

Equestrian Sport Museum

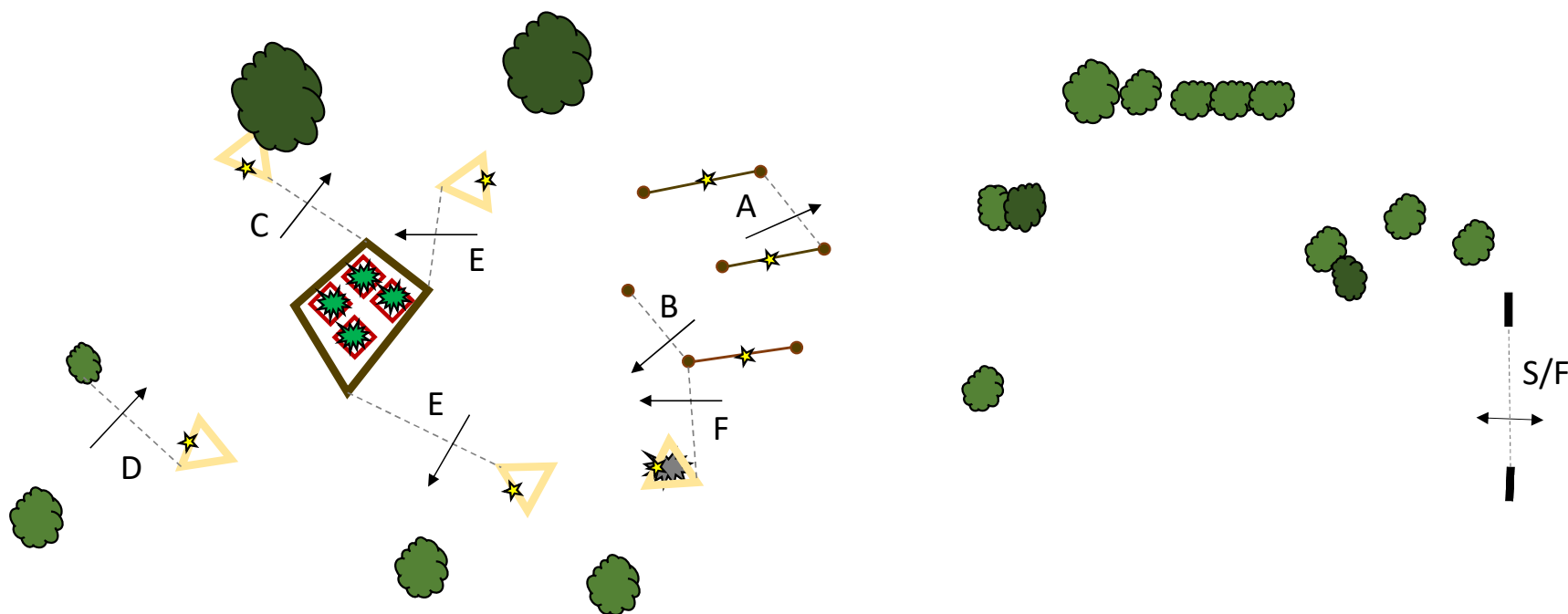

★ x 8 - dislodgeable elements

CD KRISTAPS CAUNE

CAI2*-H1; CAI2*-P1; CAI2*-P2; 11; 12 Gates – A-F

Equine College

6

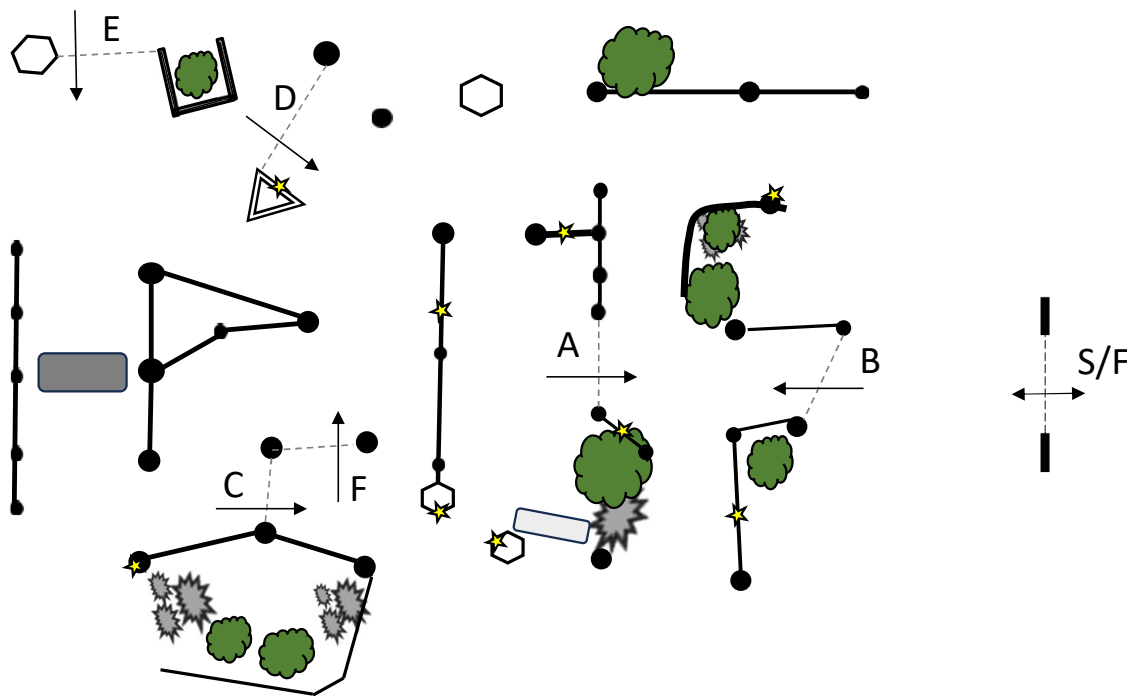

★ x 9 - dislodgable elements

CD KRISTAPS CAUNE

CAI2*-H1; CAI2*-P1; CAI2*-P2; 10; 11; 12 Gates – A-F

2; 6; 7; 8; 9 Gates A-E

CAICh2*-P1; 1; 5 Gates – A-D

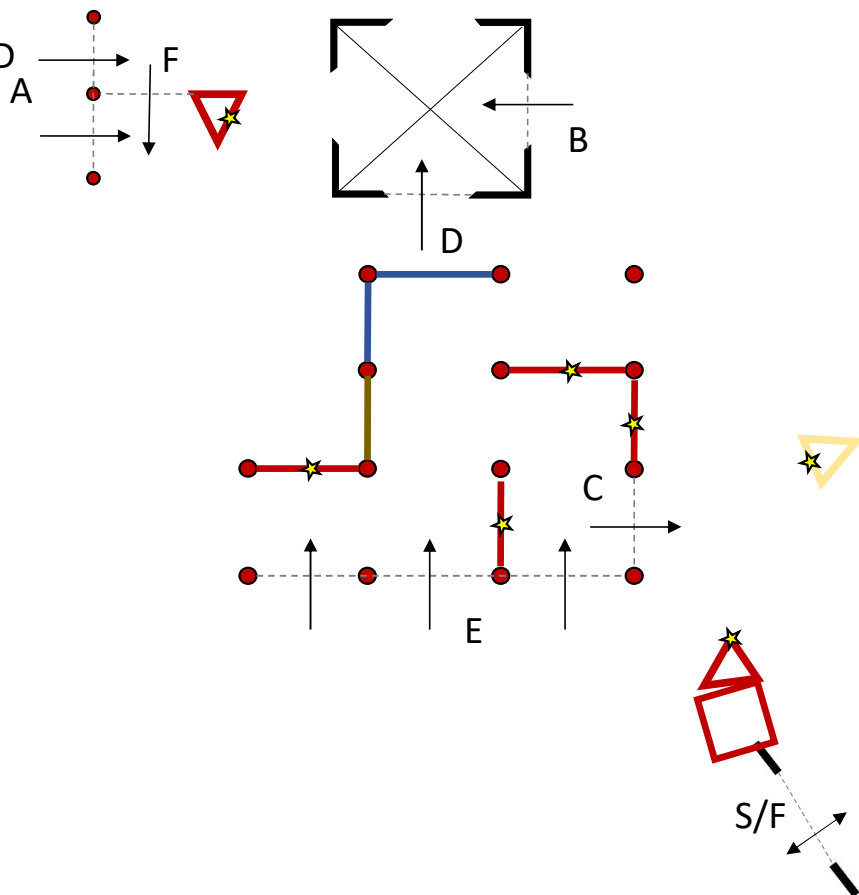

★ x 7 - dislodgable elements