

# YPÄJÄ 2024

## MARATHON INFO CAICH2\*-P1

(03.08.2024)

Course Designer – Kristaps Caune (LAT)





# YPÄJÄ 2024

## Marathon Section Times

CAICh2\*-P1  
(03.08.2024)

### Ponies

Section	Distance	Speed	Minimum Time	Time Allowed	Maximum Time	Compulsory Turning Flags
<b>In Harness Inspection</b>						
<b>Section A</b>	4955 m	12 km/h	<b>22 min 47 sec</b>	<b>24 min 47 sec</b>	<b>29 min 44 sec</b>	1 - 4
<b>Neutral Zone</b>	3 min					
<b>Rest</b>	10 min					
<b>Warm Up Obstacle</b>	max. 2 min					
<b>Section B</b> <b>O1; O2; O4;</b> <b>O5; O7</b>	4700 m	13 km/h	<b>18 min 42 sec</b>	<b>21 min 42 sec</b>	<b>43 min 24 sec</b>	1 - 9
<b>Cool Down</b> In Harness Examination	Track		10 min		15 min	



# YPÄJÄ 2024

CAICh2\*-P1

## Section A

4955 m

Start A	3 km
1 km	CTF 3
CTF 1	4 km
2 km	CTF 4
CTF 2	Finish A
	4955 m

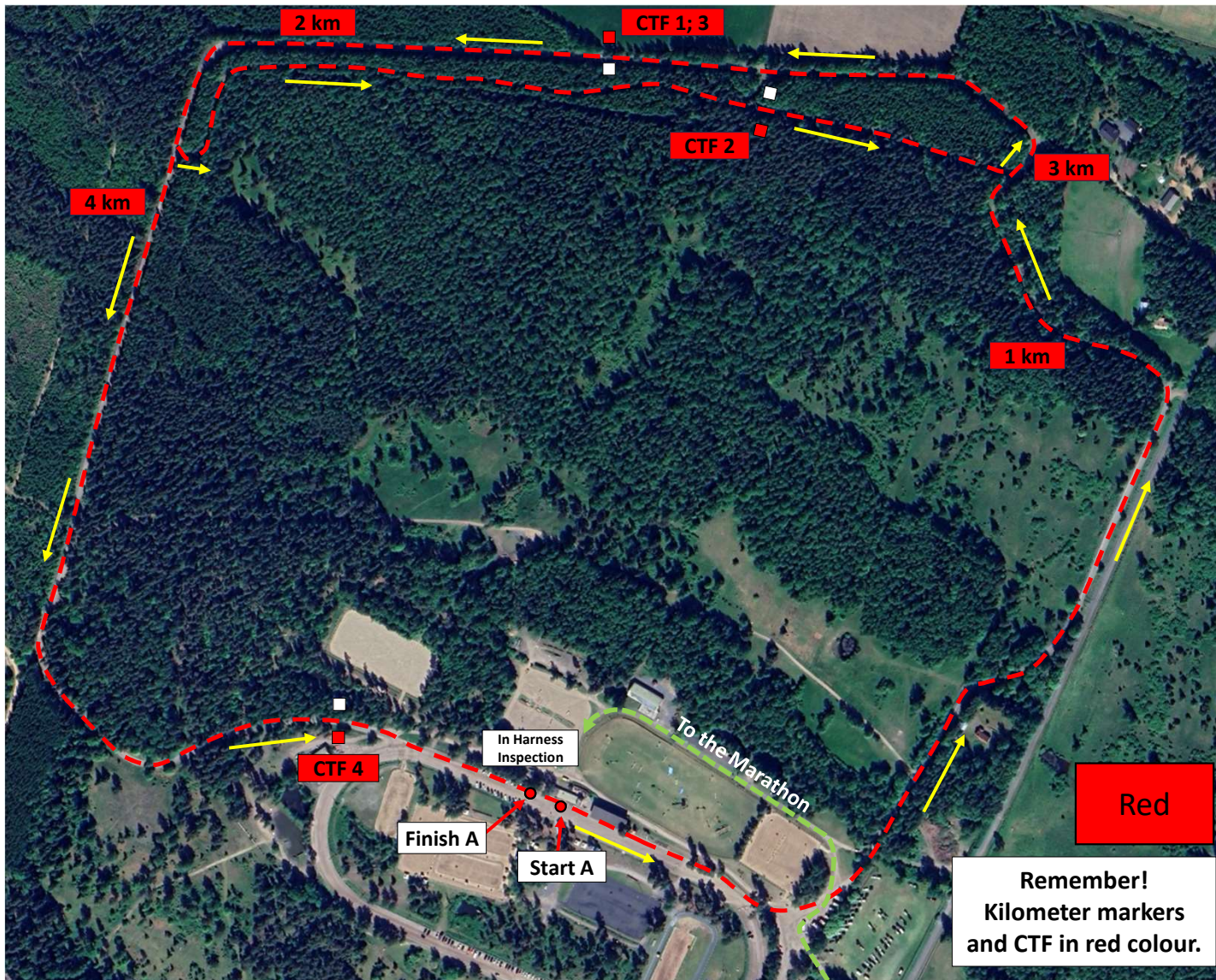

CD KRISTAPS CAUNE



# Section B (4700 m)

CAICh2\*-P1

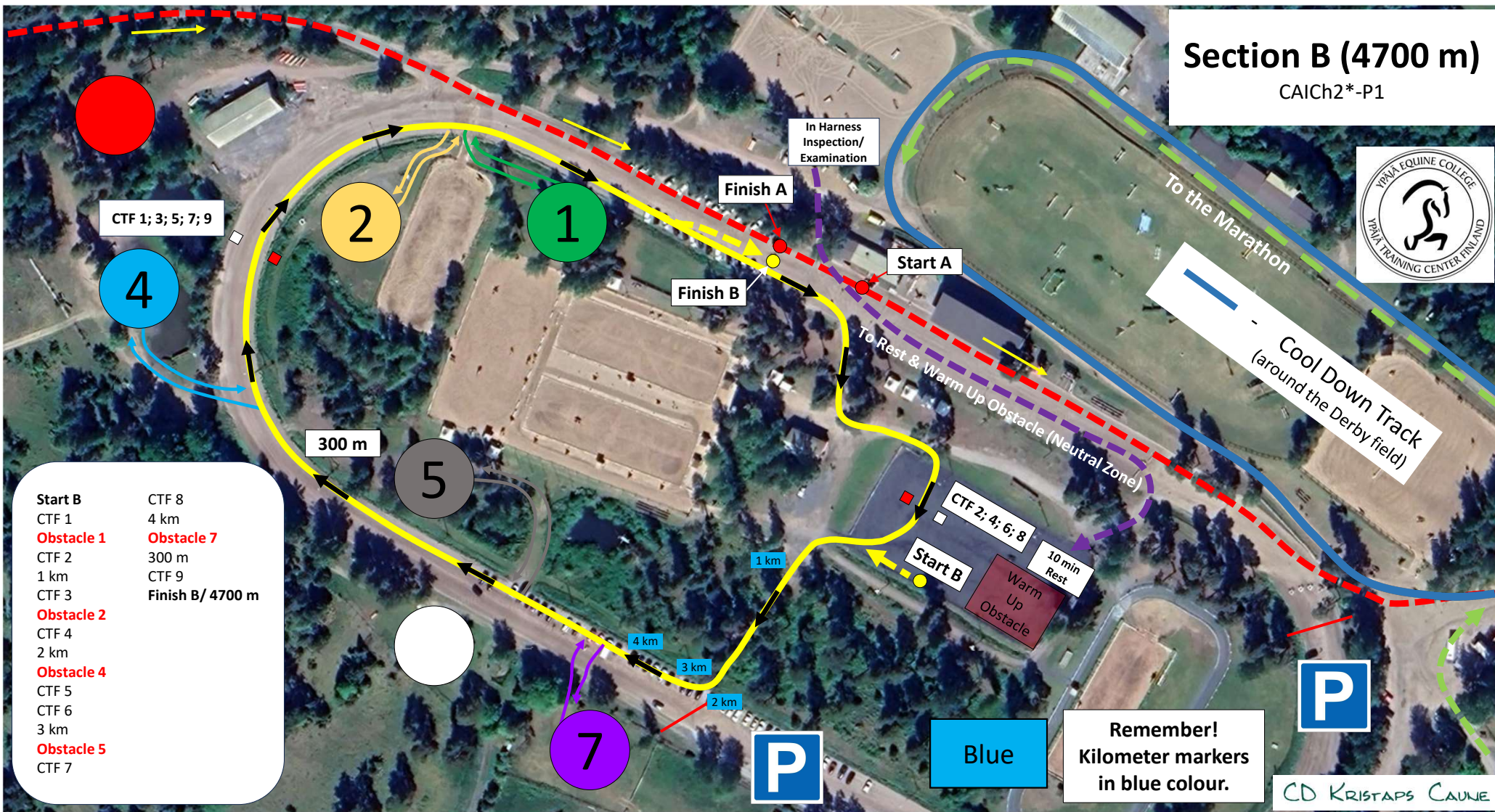

- |                   |                   |
|-------------------|-------------------|
| Start B           | CTF 8             |
| CTF 1             | 4 km              |
| <b>Obstacle 1</b> | <b>Obstacle 7</b> |
| CTF 2             | 300 m             |
| 1 km              | CTF 9             |
| CTF 3             | Finish B/ 4700 m  |
| <b>Obstacle 2</b> |                   |
| CTF 4             | 2 km              |
| <b>Obstacle 4</b> |                   |
| CTF 5             |                   |
| CTF 6             | 3 km              |
| <b>Obstacle 5</b> |                   |
| CTF 7             |                   |

**Remember!**  
Kilometer markers  
in blue colour.

CD KRISTAPS CAUNE

CAICH2\*-P1 Gates – A-D

Ypäjän Osuuspankki



1

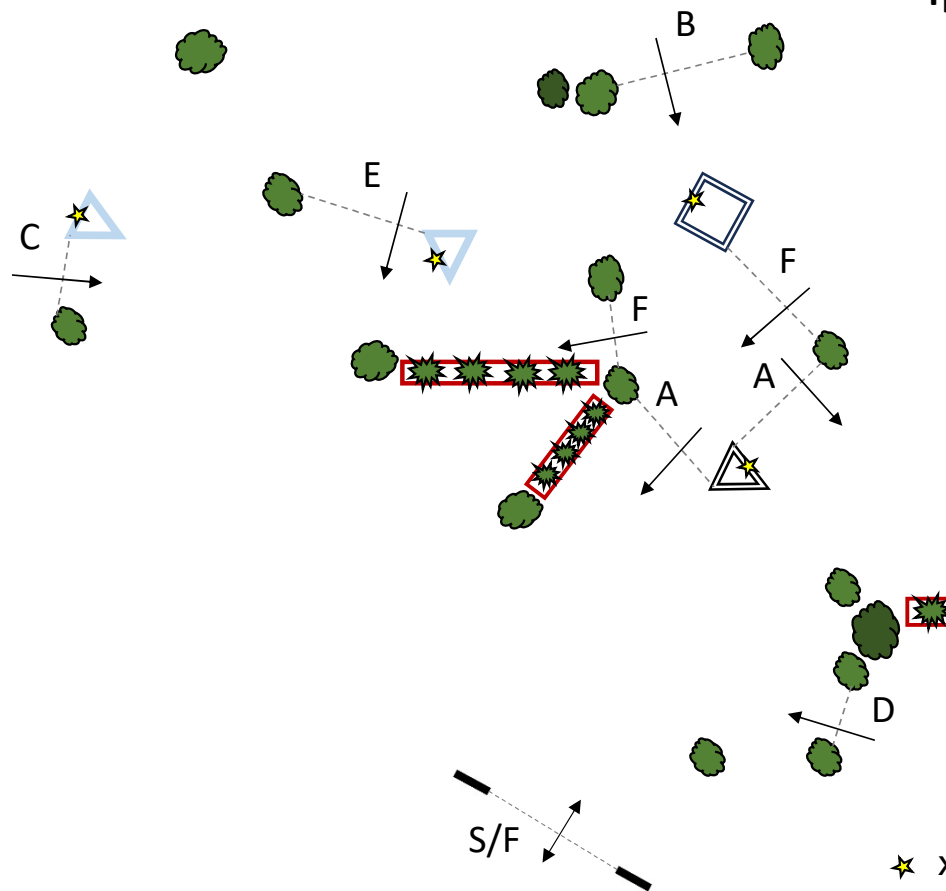

★ x 4 - dislodgeable elements

CD KRISTAPS CAUNE

CAICh2\*-P1 Gates – A-D

Equine College

2

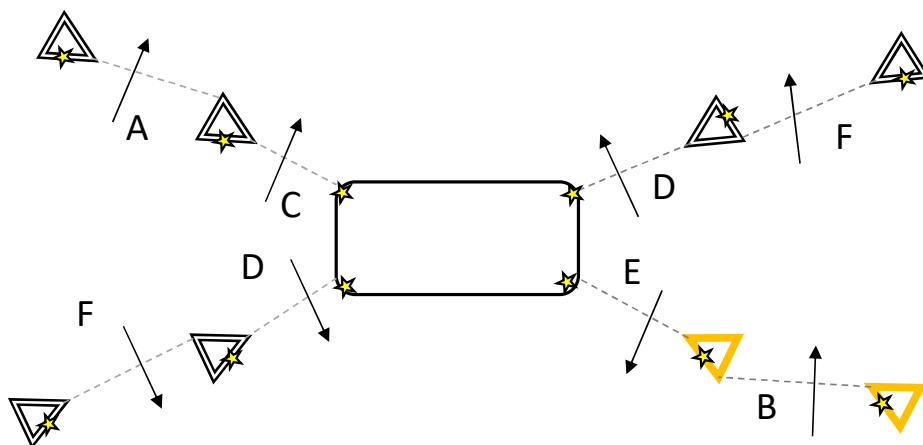
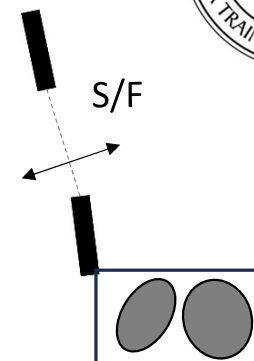
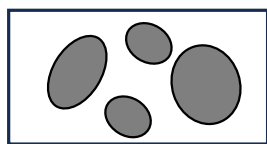

★ x 12 - dislodgeable elements

CD KRISTAPS CAUNE

CAICh2\*-P1 Gates – A-D



VaTu ry

4

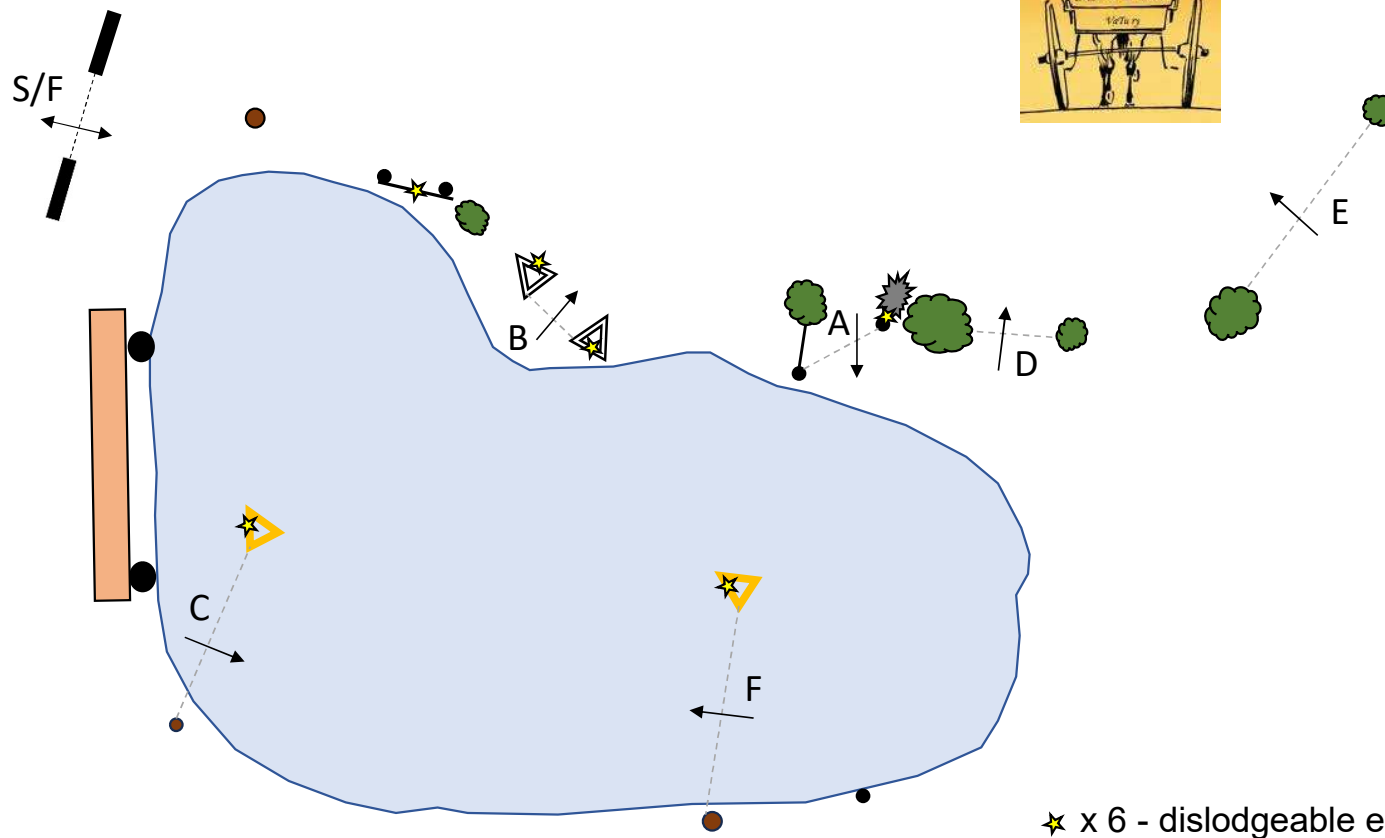

☆ x 6 - dislodgeable elements

CD KRISTAPS CAUNE

CAICh2\*-P1 Gates – A-D

Equestrian Sport Museum

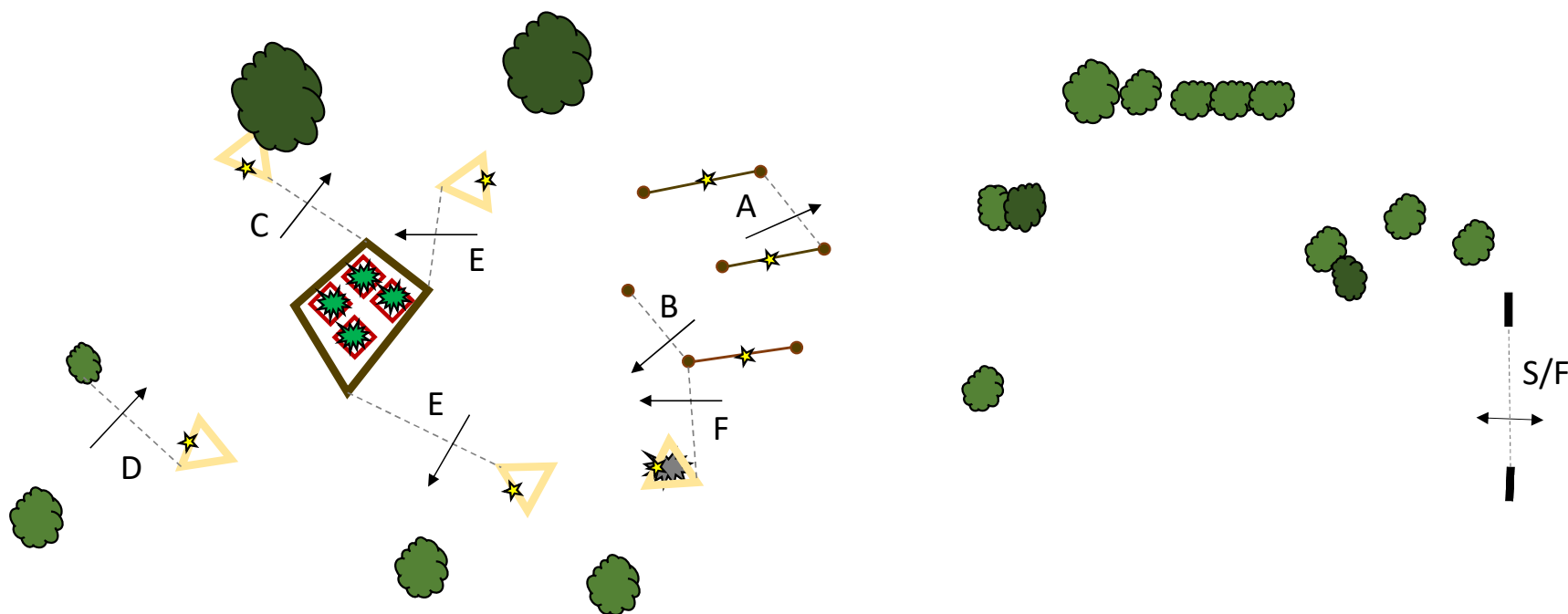

★ x 8 - dislodgeable elements

CD KRISTAPS CAUNE



CAICH2\*-P1 Gates – A-D

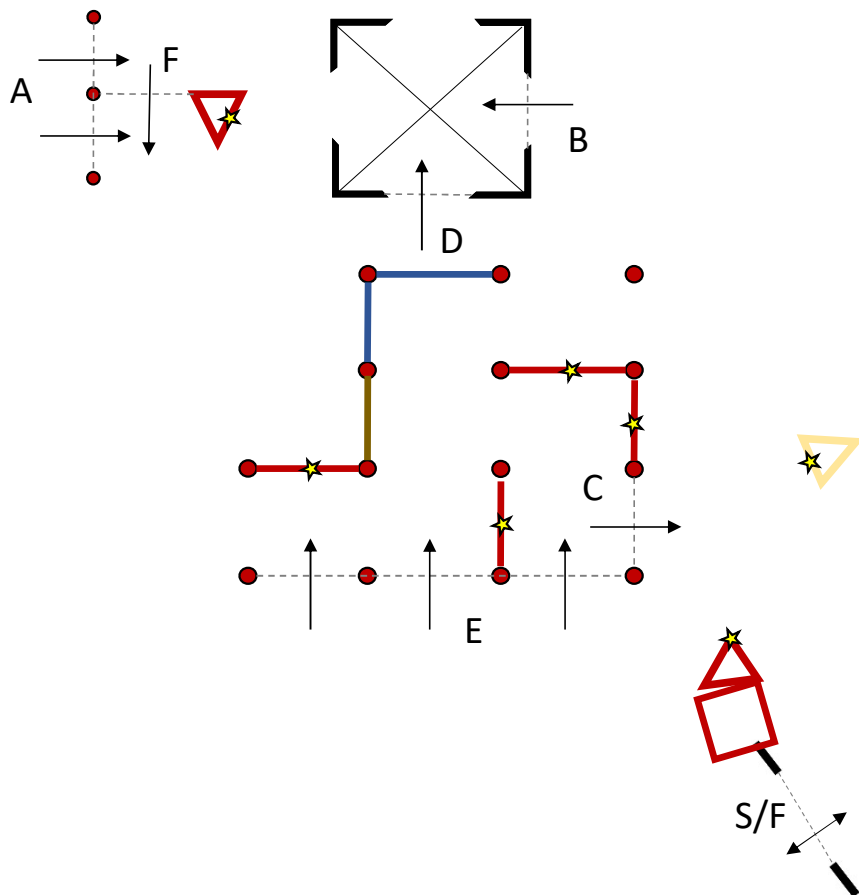

★ x 7 - dislodgable elements